

Super-Quiet Xenon Lamp

Super-Quiet Mercury-Xenon Lamp



OVERVIEW

● Super-Quiet Xenon Lamp

These are lamps filled with xenon gas that emits "white light" at a high color temperature of 6000 K, which is close to that of sunlight and covers a broad continuous spectrum from the ultraviolet to infrared region (185 nm to 2000 nm). These xenon lamps are ideal as light sources for various types of photometric instruments such as spectrophotometers.

Irradiance

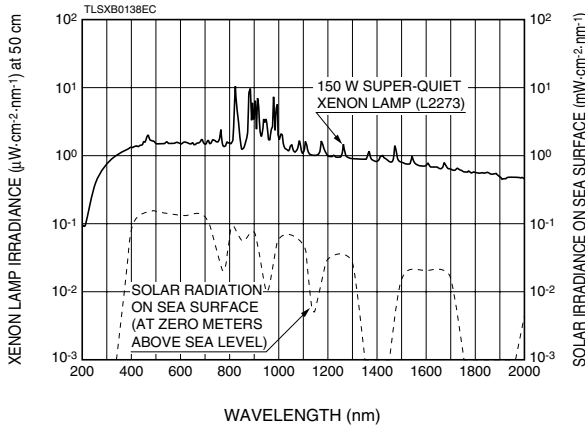

● Super-Quiet Mercury-Xenon Lamp

Mercury-xenon lamps produce high radiant energy especially in the ultraviolet region due to an optimal mixture of mercury and xenon gas. These lamps possess features of both xenon gas and mercury discharge lamps. The spectral distribution includes a continuous spectrum ranging from ultraviolet to infrared of the xenon gas and strong mercury line spectra in the ultraviolet to visible region. Compared to xenon lamps, the radiant spectrum in the ultraviolet region of mercury-xenon lamps is sharper in width and its peak is higher in intensity. These features make mercury-xenon lamps ideal as ultraviolet light sources.

Irradiance

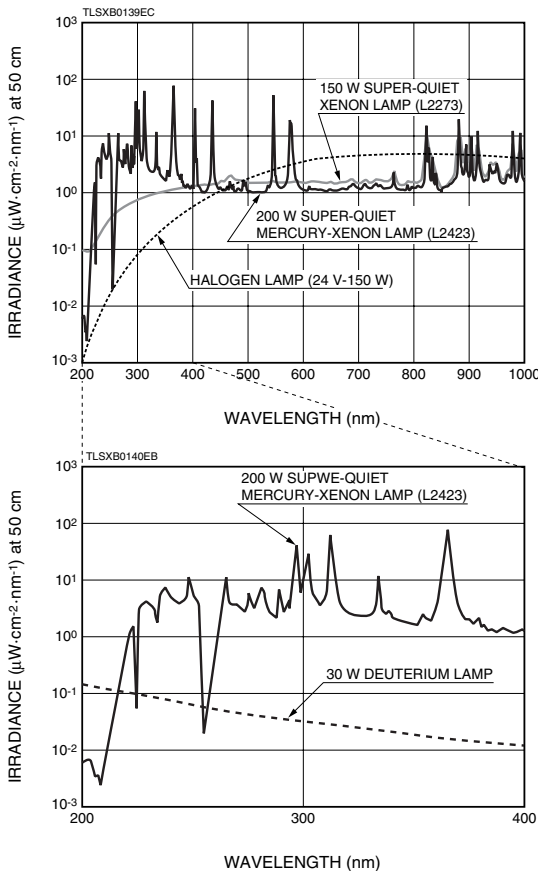

FEATURES

● No arc point shift

● High stability

Xenon lamp:

Fluctuation (p-p) 0.2 % Typ.

1.0 % Max.

Drift

± 0.5 %/h Typ.

Mercury-xenon lamp:

Fluctuation (p-p) 0.5 % Typ.

2.0 % Max.

Drift

± 0.5 %/h Typ.

● Long life

● Wide lamp lineup starting from low wattage input

● High intensity point light source

● High color temperature: 6000 K (Super-quiet xenon lamp)

● High UV intensity (Super-quiet mercury-xenon lamp)

APPLICATIONS

● Super-Quiet Xenon Lamp

- Spectrophotometer
- Liquid chromatograph
- Fluorospectrophotometer
- Microscope Light Source
- Color analyzer, color scanner
- Solar simulator, etc.

● Super-Quiet Mercury-Xenon Lamp

- Wafer inspection system
- Semiconductor photolithographic equipment
- Fluorescent microscopy
- Blood analyzer
- UV irradiation equipment, etc.

ARC "INSTABILITY (FLUCTUATION)" and "SHIFT"

Light source lamps used for high precision photometry must have good arc stability. However, cathodes used in conventional lamps have two shortcomings in terms of arc stability. One problem is that the arc emission point shifts intermittently due to inadequate electron emission from the cathode. The other problem is that the arc point shifts a little at a time due to the cathode tip wear that occurs with operating time as the lamp ages.

Hamamatsu super-quiet lamps employ a high performance "BI (Barium-Impregnated) cathode" developed totally in-house that eliminates the above problems to deliver extremely high stability. This durable cathode exhibits no wear at the cathode tip over operating time and the arc point does not shift. So there is no need to realign the optical system until the time finally comes when the lamp must be replaced.

Figure 1: "Fluctuation vs. Operating Time" Measurement Block Diagram

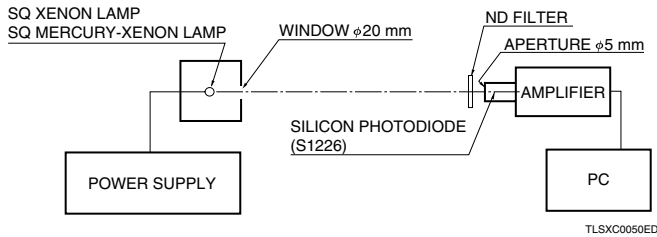

Figure 2: Fluctuation vs. Operating Time

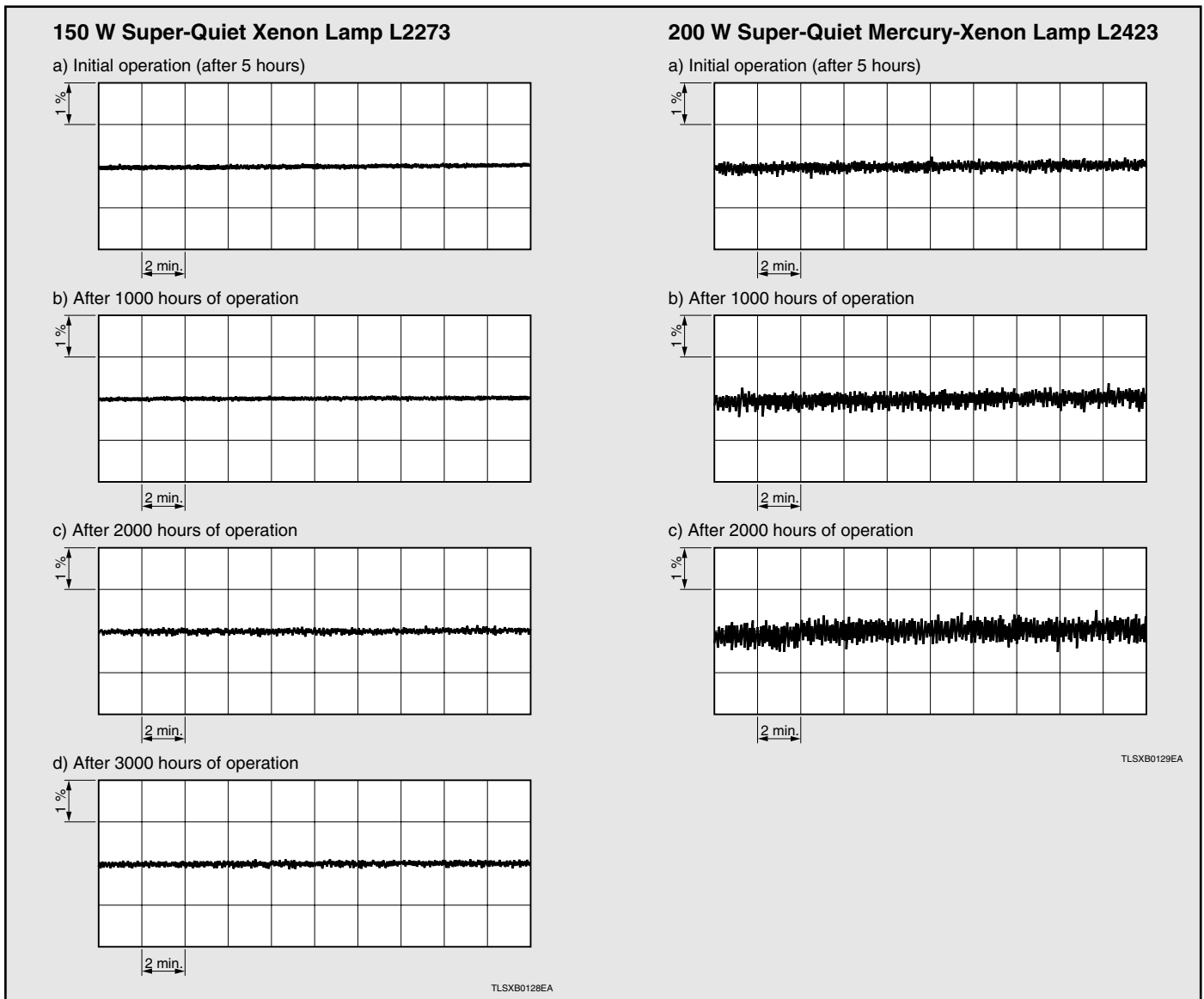
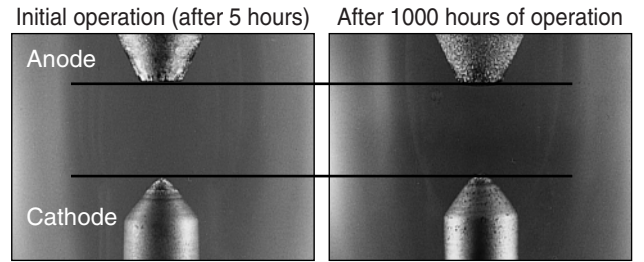
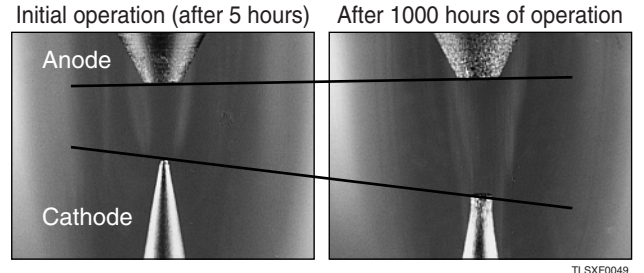

Figure 3: Comparison of Cathode Tip Wear

HAMAMATSU High performance "BI (Barium-Impregnated) cathode"



Conventional cathode



STRUCTURE AND OPERATION

These lamps have an oval bulb made of quartz glass (silica glass) in which a cathode and an anode face each other. The bulb for super-quiet xenon lamps is filled with high-purity, high-pressure xenon gas. The bulb for super-quiet mercury-xenon lamps is filled with a mixture of high-purity, high-pressure xenon gas and high-purity mercury. The lamps emit light by arc discharge. The lamps are installed vertically (or horizontally) with the anode at the upper side (some types of lamps are only installed vertically) and operate on DC. When the specified voltage is supplied across the anode and cathode, the lamp immediately starts discharging to form an arc discharge. After the lamp lights up, several minutes are required to reach the maximum light output because the gas pressure inside the bulb changes until it reaches thermal equilibrium. During lamp operation, the bulb wall temperature rises above 500 °C and the gas pressure inside the bulb increases to approximately 4 MPa which is 4 times higher than when the lamp is not operating.

Figure 4: Lamp Structure

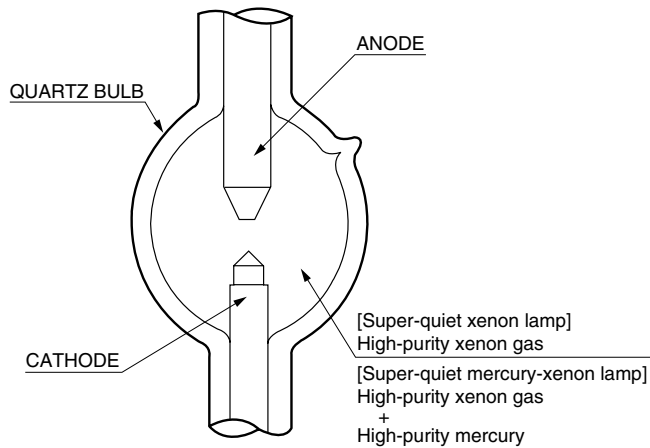

TLSXC0047EA

CHARACTERISTICS

●Irradiance

Super-Quiet Xenon Lamp

The irradiance of xenon lamps is continuous over the ultraviolet, visible and infrared regions. Some line spectra are emitted in the visible to infrared regions.

Super-Quiet Mercury-Xenon Lamp

The irradiance of mercury-xenon lamps has strong line spectra from the ultraviolet to the visible region. This radiation spectrum includes both the radiation spectrum of xenon lamps and mercury line spectra.

Figure 5: Irradiance

Super-Quiet Xenon Lamp

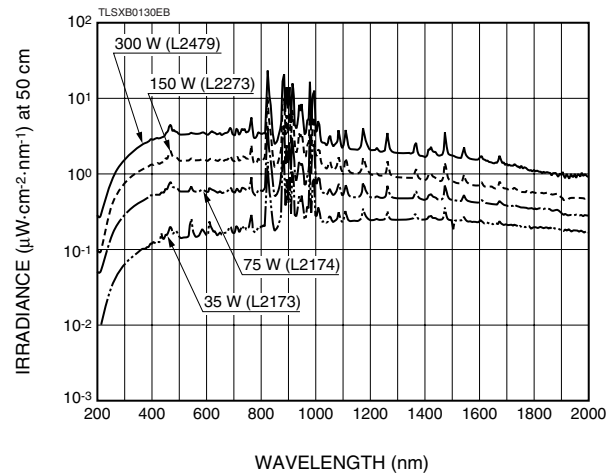

Super-Quiet Mercury-Xenon Lamp

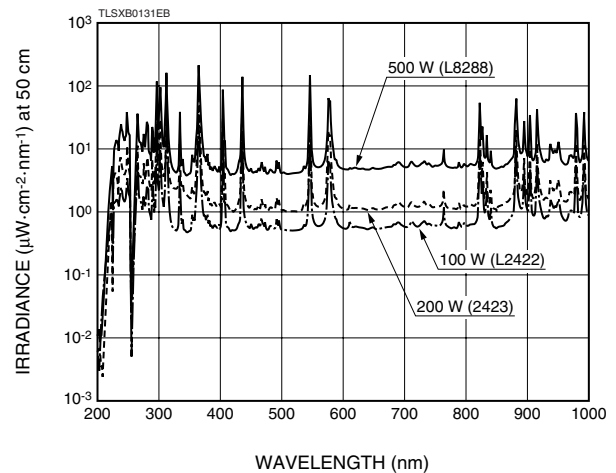

●Difference in Irradiance by Bulb Material

The irradiance differs according to the bulb material. Fused silica transmits light at wavelengths shorter than 240 nm, yet ozone-free silica cuts off light of wavelengths shorter than 240 nm. Select the bulb material that meets your application.

Figure 6: Irradiance Comparison of Different Bulb Materials

150 W Super-Quiet Xenon Lamp

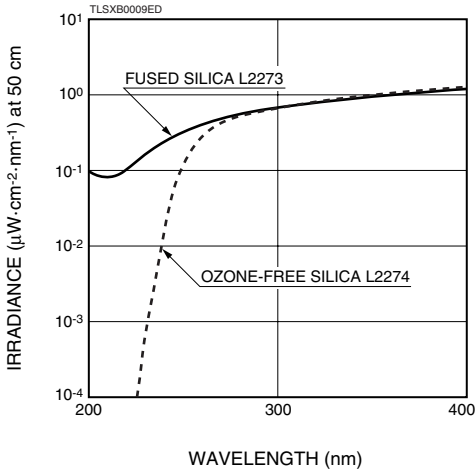

●Light Output Intensity Contour Map

Maximum light output intensity is more intense around the cathode, and decreases towards the anode.

Figure 7: Light Output Intensity Contour Map (Vertical Lightning)

150 W Super-Quiet Xenon Lamp L2273

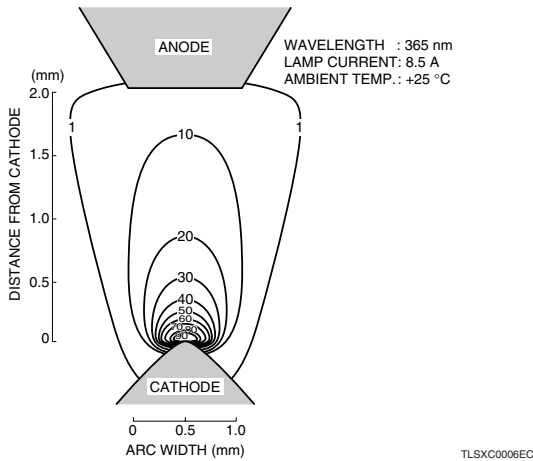

200 W Super-Quiet Mercury-Xenon Lamp L2423

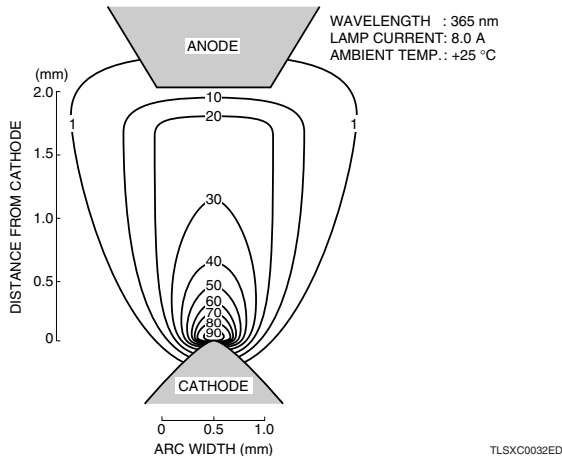

●Radiant Flux Distribution

The lamps emit a radiant flux distribution uniformly along the horizontal direction.

Figure 8: Radiant Flux Distribution (Vertical Lighting)

**150 W Super-Quiet Xenon Lamp L2273
200 W Super-Quiet Mercury-Xenon Lamp L2423**

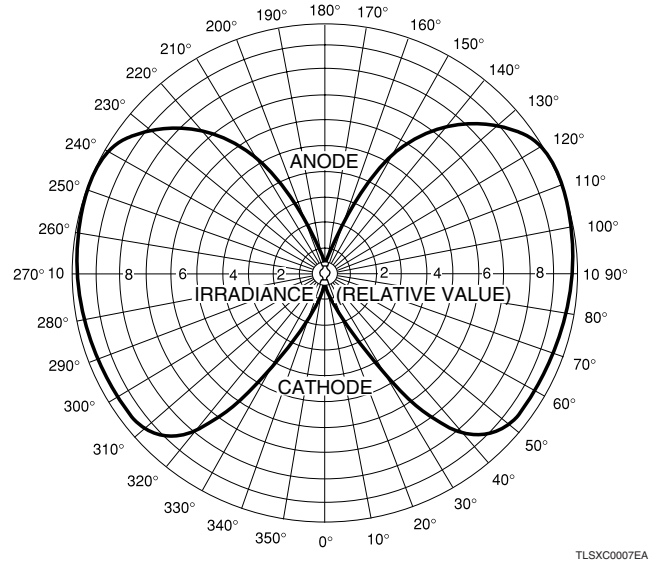

●Lamp Current and Lamp Voltage

Figure 9: Lamp Current vs. Lamp Voltage

150 W Super-Quiet Xenon Lamp L2273

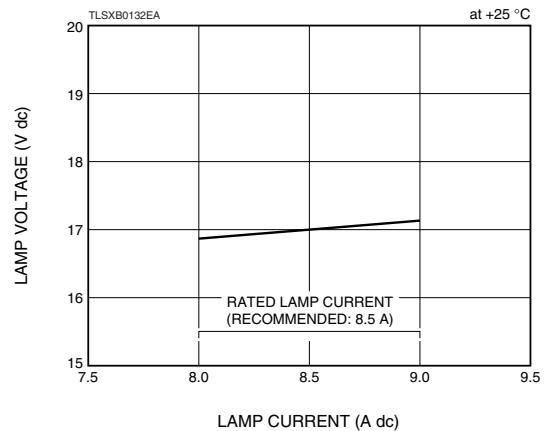

200 W Super-Quiet Mercury-Xenon Lamp L2423

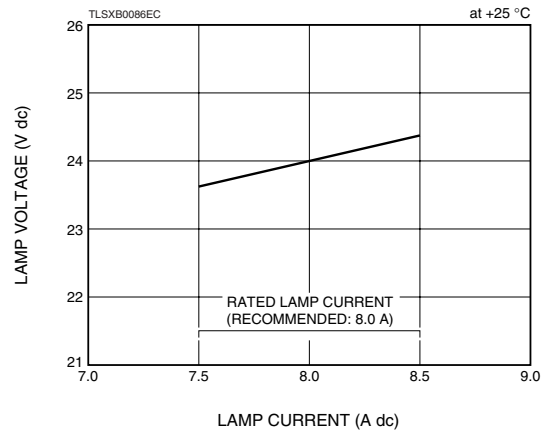

●Light Output Intensity and Lamp Current

The light output intensity of a lamp is proportional to the lamp current.

Figure 10: Light Output Intensity vs. Lamp Current

150 W Super-Quiet Xenon Lamp L2273

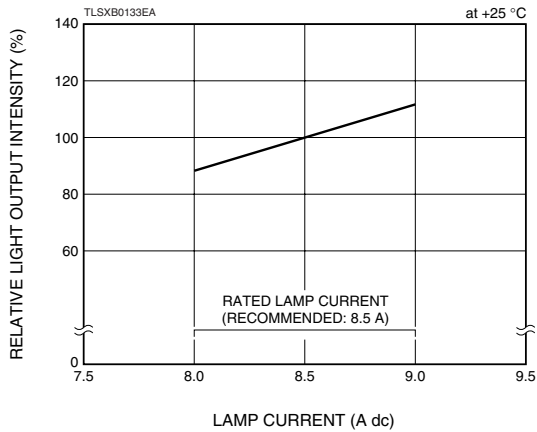

200 W Super-Quiet Mercury-Xenon Lamp L2423

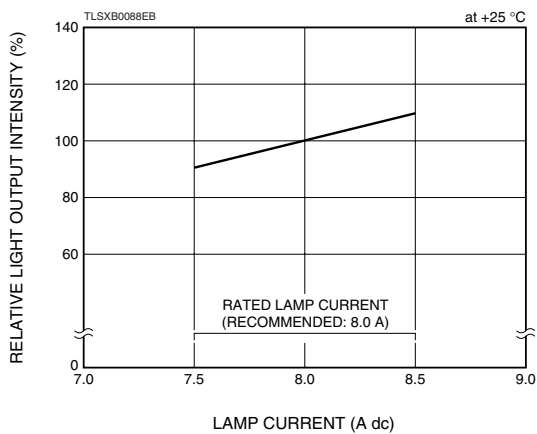

●Initial Stability of Light Output Intensity

After the lamp lights up, the light output intensity varies until the gas pressure inside the bulb reaches thermal equilibrium. It takes several minutes to reach the maximum light output.

Figure 11: Initial Stability of Light Output Intensity

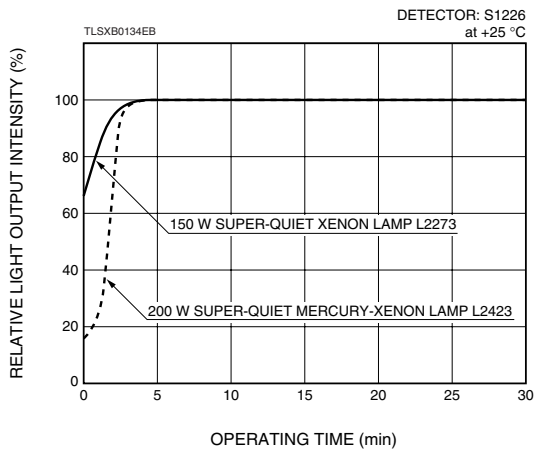

●Light Output Intensity and Ambient Temperature

The light output intensity of a lamp also varies with ambient temperature. This is due to the change in light output intensity resulting from the change in gas pressure with temperature. The ambient temperature must be kept constant to ensure stable lamp operation.

Figure 12: Light Output Intensity vs. Ambient Temperature

150 W Super-Quiet Xenon Lamp L2273

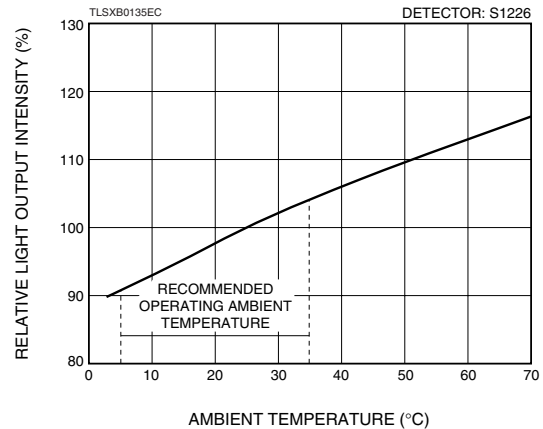

●Light Output Intensity and Operating Time

The light output intensity decreases over operating time. This is because of a loss of glass transmittance caused by blacking of the bulb wall due to evaporation of the cathode materials and solarization effect of ultraviolet radiation.

Figure 13: Light Output Intensity vs. Operating Time

150 W Super-Quiet Xenon Lamp L2273

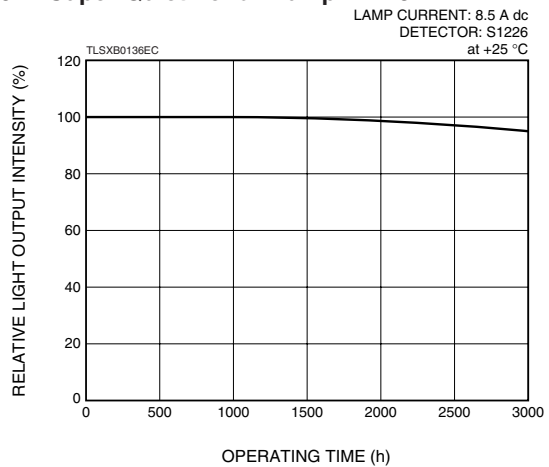

200 W Super-Quiet Mercury-Xenon Lamp L2423

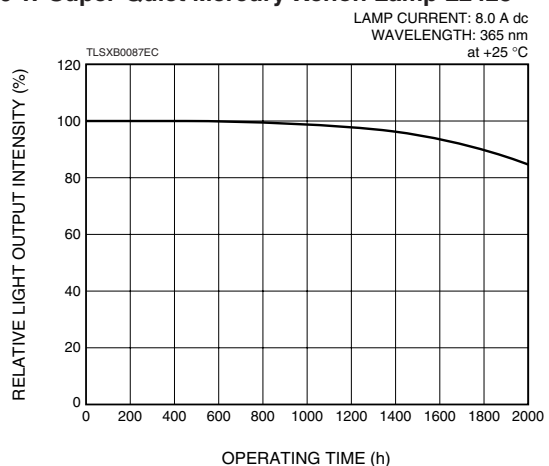

POWER SUPPLY

Lamps used as a light source for photometric applications must provide stable light output. To ensure stable lamp operation, the power supply must also provide high stability equal to or better than that of the lamp.

Figure 14: Block Diagram of Regulated Power Supply

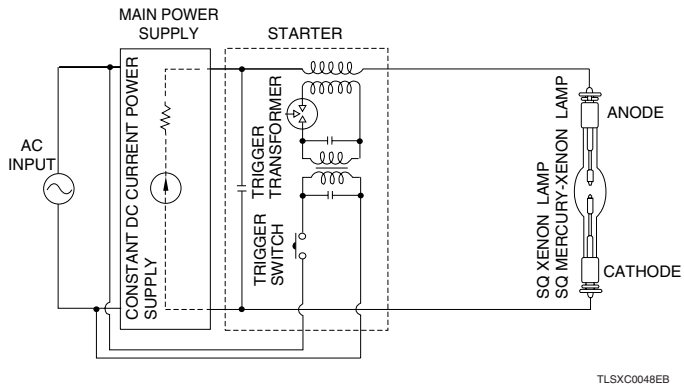

●Main Power Supply

Besides supplying the lamp with stable DC power, the main power supply gives the cathode an optimal operating temperature at a specified current. The cathode temperature is very important for lamp operation. A cathode temperature that is too high speeds up the evaporation of cathode materials. Too low of a temperature will increase the load on the cathode, causing unstable electron emission and greatly reducing the lamp service life.

The lamp current must be set within the specified range to operate the lamp stably over long periods of time. For this reason, the operating current value and its range are specified for each lamp type.

●Starter

The starter is for starting lamp discharge. It applies a high-frequency pulse to the lamp load by inductive coupling. (See Figure 14.) In the initial stage of lamp operation, the discharge starts at approximately 10 kV. However, this characteristic varies according to the drop in electron emission capability of the cathode or variations in the fill gas pressure.

In actual equipment operation, a trigger voltage of 20 kV to 30 kV should be applied to the lamp, while taking an ample safety margin into account.

SPECIFICATIONS

SUPER-QUIET XENON LAMP

Type No.	Lamp Rating (W)	Arc Length (mm)	Lamp Current (A dc)	Lamp Voltage (V dc)	Window Material (Transmission Wavelength) (nm)	Light Output Stability	
						Drift Typ. (%/h)	Fluctuation (p-p) Max. (%)
L2173	35	1.0	3.5±0.2	11	Fused Silica (185 to 2000)	±0.5	1.0
L2193					Ozone-free Silica (240 to 2000)		
L2174	75	1.3	5.4±0.5	15	Fused Silica (185 to 2000)	±0.5	1.0
L2174-01							
L2174-02							
L2194							
L2194-01							
L2194-02							
L2194-11		1.0	13	Ozone-free Silica (240 to 2000)			
L10725	75	1.0	5.7±0.3	13.5	Fused Silica (185 to 2000)	±0.5	1.0
L10725-01							
L10725-02							
L10726							
L10726-01							
L10726-02							
L11307	100	1.3	7.0±0.5	15	Fused Silica (185 to 2000)	±0.5	1.0
L11307-01							
L9289							
L9289-01							
L2175	150	2.5	7.5±0.5	19	Fused Silica (185 to 2000)	±0.5	1.0
L2195		2.0			8.5±0.5		
L2273			Fused Silica (185 to 2000)				
L2274			Ozone-free Silica (240 to 2000)				
L11033			Fused Silica (185 to 2000)				
L11034			Ozone-free Silica (240 to 2000)				
L2479		300	3.0	15.0±1.0	20		
L2480	Ozone-free Silica (240 to 2000)						

SUPER-QUIET MERCURY-XENON LAMP

Type No.	Lamp Rating (W)	Arc Length (mm)	Lamp Current (A dc)	Lamp Voltage (V dc)	Window Material (Transmission Wavelength) (nm)	Light Output Stability	
						Drift Typ. (%/h)	Fluctuation (p-p) Max. (%)
L2421	50	1.0	3.5±0.2	14	Fused Silica (185 to 2000)	±0.5	2.0
L2481	75	1.0	5.4±0.5	14	Fused Silica (185 to 2000)	±0.5	2.0
L2481-01							
L2481-02							
L2422	100	1.3	5.5±0.5	18	Fused Silica (185 to 2000)	±0.5	2.0
L2422-01							
L2422-02							
L7046		0.8			Fused Silica (185 to 2000)		
L8029							
L8029-01							
L2482	150	1.7	7.5±0.5	20	Fused Silica (185 to 2000)	±0.5	2.0
L7047					Ozone-free Silica (240 to 2000)		
L2423	200	2.0	8.0±0.5	24	Fused Silica (185 to 2000)	±0.5	2.0
L2570					Ozone-free Silica (240 to 2000)		
L8706	250	1.8	8.5±0.5	27	Fused Silica (185 to 2000)	±0.5	3.0
L2483	350	2.5	14.0±1.0	25	Fused Silica (185 to 2000)	±0.5	2.0
L2917					Ozone-free Silica (240 to 2000)		
L8288	500	3.0	20.0±1.0	25	Fused Silica (185 to 2000)	±0.5	2.0

NOTE: Ⓐ The life end is defined as the time when the light output intensity falls to 50 % of its initial value or when the output fluctuation (p-p) exceeds 1.0 % for super-quiet xenon lamps and 2.0 % for super-quiet mercury-xenon lamps (3.0 % for 250 W type L8706).

Ⓑ Open-circuit voltage necessary for certain lighting of lamps.

Ⓒ See pages 10 and 11.

Guaranteed Operation Life (h) ^A	Average Life (h)	Orientation (degree)	Cooling Method	Supply Voltage Min. (V dc) ^B	Trigger Voltage (kV)	Dimensional Outline ^C	Weight (g)	Applicable Power Supply + Starter + Lamp Housing ^D	Type No.	
1000	2000	Vertical ±15 or Horizontal ±15	Convection Cooling	50	15	②	14	①	L2173	
									L2193	
1000	2000	Vertical ±15 or Horizontal ±15	Convection Cooling	50	15	②	15		L2174	
						③	19		L2174-01	
						④	15		L2174-02	
						②	15		L2194	
						③	19		L2194-01	
						④	15		L2194-02	
						③	15		L2194-11	
2000	3000	Vertical ±15 or Horizontal ±15	Convection Cooling	50	15	②	15		②	L10725
						③	19			L10725-01
						④	15	L10725-02		
						②	15	L10726		
						③	19	L10726-01		
						④	15	L10726-02		
1500	2500	Vertical ±15 or Horizontal ±15	Convection Cooling	50	15	②	15	③	L11307	
						③			L11307-01	
						②			L9289	
						③			L9289-01	
1200	2500	Vertical ±15 or Horizontal ±15	Convection Cooling	65	20	⑤	45	④,⑤	L2175	
1800	3000								L2195	
3000	4000								L2273	
									L2274	
									L11033	
									L11034	
1000	2000	Vertical ±15 or Horizontal ±15	Forced Cooling	80	25	⑦	68	⑥,⑦	L2479	
									L2480	

Guaranteed Operation Life (h) ^A	Average Life (h)	Orientation (degree)	Cooling Method	Supply Voltage Min. (V dc) ^B	Trigger Voltage (kV)	Dimensional Outline ^C	Weight (g)	Applicable Power Supply + Starter + Lamp Housing ^D	Type No.	
500	1000	Vertical ±15 or Horizontal ±15	Convection Cooling	50	15	①	10	①	L2421	
500	1000	Vertical ±15 or Horizontal ±15	Convection Cooling	50	15	②	14		L2481	
						③	18		L2481-01	
						④	15		L2481-02	
500	1000	Vertical ±15 or Horizontal ±15	Convection Cooling	50	15	②	15		L2422	
						③	19		L2422-01	
		Vertical ±15				④	15		L2422-02	
						②	15		L7046	
1000	2000					③	15		L8029	
										L8029-01
1000	2000	Vertical ±15 or Horizontal ±15	Convection Cooling	65	20	⑤	43		④,⑤	L2482
								L7047		
								L2423		
1000	2000	Vertical ±15 or Horizontal ±15	Convection Cooling	65	20	⑤	45		L2570	
2000	3000	Vertical ±15	Forced Cooling	65	20	⑥	62	— ^E	L8706	
500	1000	Vertical ±15	Forced Cooling	70	25	⑦	68	⑥,⑦	L2483	
									L2917	
1000	2000	Vertical ±15	Forced Cooling	80	30	⑦	80	⑥,⑦	L8288	

NOTE: ① Power supplies should be used in combination with a starter (sold separately) or lamp housing.
 ② Please consult us.

DIMENSIONAL OUTLINES (Unit: mm)

① Super-Quiet Mercury-Xenon Lamp: L2421

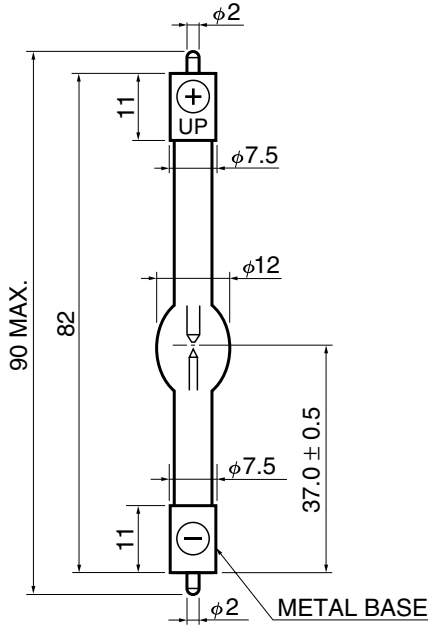

TLSXA0045ED

② Super-Quiet Xenon Lamp: L2173, L2193, L2174, L2194, L10725, L10726, L11307, L9289
Super-Quiet Mercury-Xenon Lamp: L2481, L2422, L7046

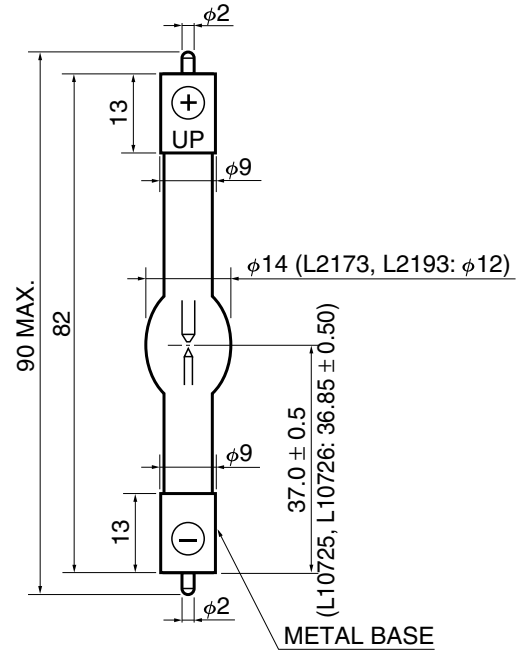

TLSXA0101EB

③ Super-Quiet Xenon Lamp: L2174-01, L2194-01/-11, L10725-01, L10726-01, L11307-01, L9289-01
Super-Quiet Mercury-Xenon Lamp: L2481-01, L2422-01, L8029-01

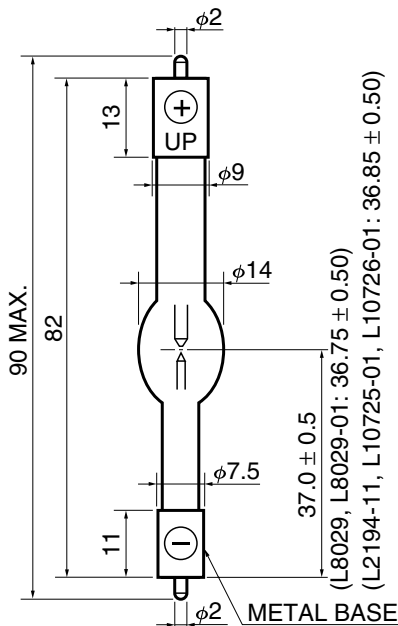

TLSXA0102EB

④ Super-Quiet Xenon Lamp: L2174-02, L2194-02, L10725-02, L10726-02
Super-Quiet Mercury-Xenon Lamp: L2481-02, L2422-02

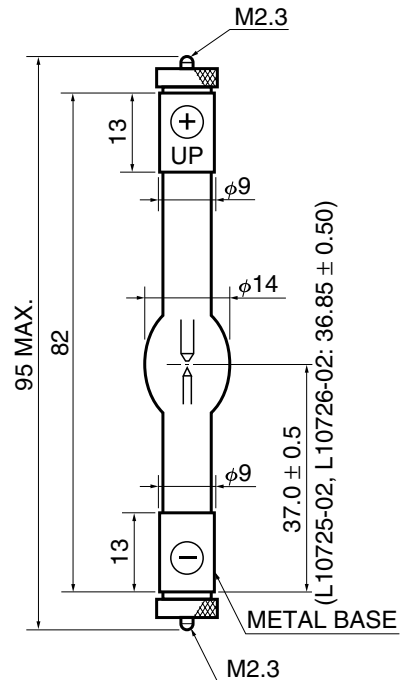

TLSXA0007EE

5 Super-Quiet Xenon Lamp: L2175, L2195, L2273, L2274, L11033, L11034
 Super-Quiet Mercury-Xenon Lamp: L2482, L7047, L2423, L2570

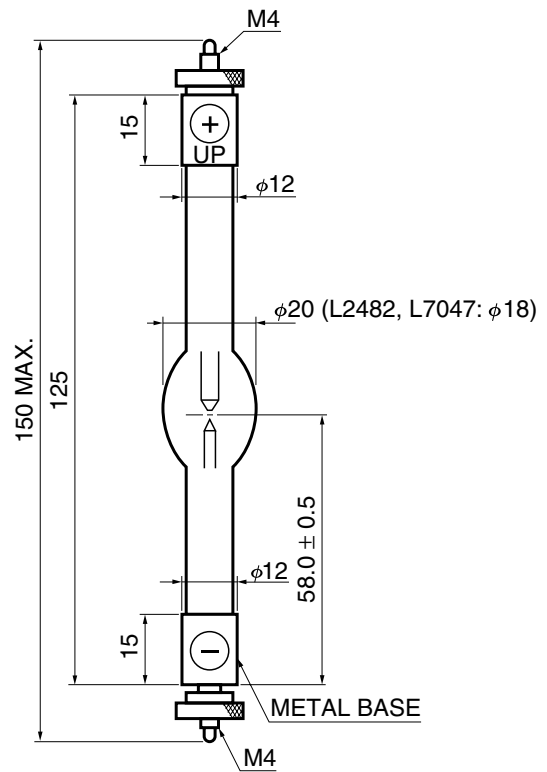

TLSXA0103EA

6 Super-Quiet Mercury-Xenon Lamp: L8706

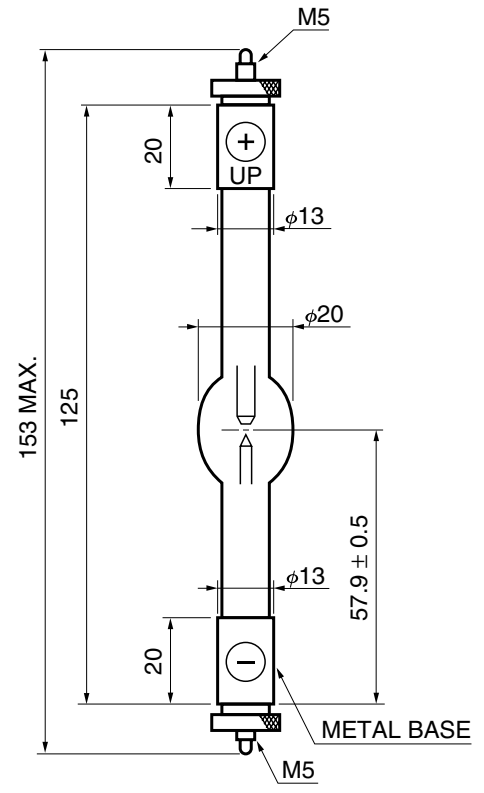

TLSXA0092EB

7 Super-Quiet Xenon Lamp: L2479, L2480
 Super-Quiet Mercury-Xenon Lamp: L2483, L2917, L8288

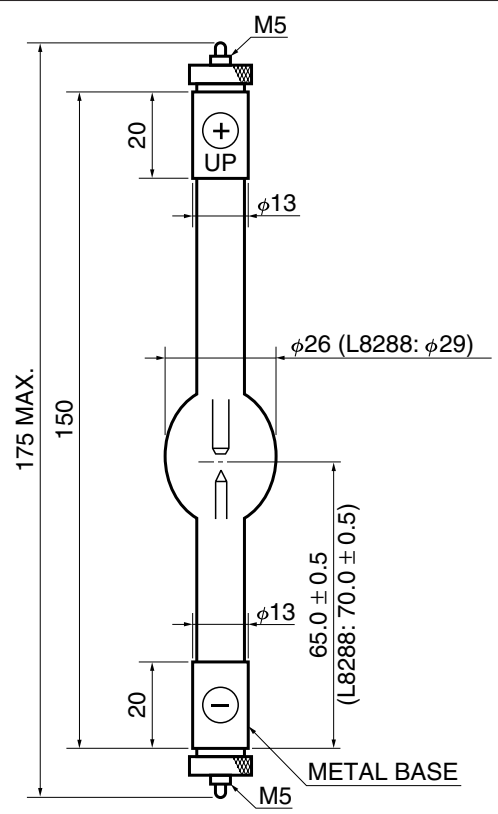

TLSXA0104EA

Applicable Power Supply + Starter[Ⓐ] + Lamp Housing Combination

	Applicable Power Supply Type No.	Applicable [Ⓐ] Starter Type No.	Applicable Lamp Housing Type No.
①	C8848	C4251	E2419 Series [Ⓑ]
②	C8848-00-57		
③	C8849-00-70		
④	C8849	—	E7536 Series [Ⓒ]
⑤	C8849	C4251	E2420
⑥	C11320	—	E10180 Series [Ⓒ]
⑦	C11320	C4339	E5421

See also pages 9 and 12.

- NOTE:** [Ⓐ] Starters are sold separately.
[Ⓑ] Two types of heatsink fins (7.5 mm and 9 mm diameter) are available to match different lamp metal bases.
[Ⓒ] Has an internal starter.

POWER SUPPLY

Lamps used as the light source for photometric applications must provide stable light output. We recommend using Hamamatsu dedicated power supplies for lamp operation. Using these dedicated power supplies allow extracting the full performance from our super-quiet lamps.

Select the power supply that matches your application. We also provide OEM power supplies, so please feel free to consult us.



Left: C8848, C8849

Right: Starter C4251 (Sold Separately)

Power Supply										Starter		
Type No.	Control Method	Suitable Lamp Rating (W)	Suitable Lamp Current (A dc)	Input Voltage (V ac)	Discharge Current Stability (at 25 °C)		Dimension W × H × D (mm)	Weight (kg)	Start Method	NOTE	Type No.	Dimension W × H × D (mm)
					Drift Max. (%/h)	Ripple (p-p) Max. (%)						
C8848	Switching Constant Current	35 to 75 (Xenon) 50 to 100 (Mercury-Xenon)	3.5 / 5.4 / 5.5	100 to 240	±0.1	0.1	144 × 90 × 282	2.7	Manual	CE marking compliance High stability With time counter	C4251	100 × 60 × 89
C8848-00-57		35 to 75 (Xenon) 50 to 75 (Mercury-Xenon)	3.5 / 5.4 / 5.7									
C8849-00-70		100 to 150 (Xenon) 200 (Mercury-Xenon)	7.0 / 8.0 / 8.5									
C8849		150 (Xenon) 150 to 200 (Mercury-Xenon)	7.5 / 8.0 / 8.5									
C11320	Dropper Constant Current	300 (Xenon) 350, 500 (Mercury-Xenon)	14 / 15 / 20	100 / 115 / 200 / 230			165 × 272 × 360				C4339	111 × 65 × 102

NOTE: (A) Set the lamp current to the rated current by using the output current selector switch. (B) Excluding projecting parts

(C) There are 2 ways for triggering.

Manual : Turn "Lamp On" switch on after "Power" switch, then ignite lamp. This manual mode should be suitable laboratory experiments.

Auto : Simultaneously ignite lamp with "Power" switch on. Auto mode should be suitable for production line or installation to an equipment.

(D) Selectable for auto mode

(E) Power supply must be used with a starter (sold separately). (See "Applicable Power Supply + Starter + Lamp Housing Combination" on page 11.)

(F) Setting at factory prior to shipment.

CAUTION: These power supplies use a trigger mode in which a positive high voltage is applied to the anode.

Use extreme caution concerning the insulation for the anode.

SET UP

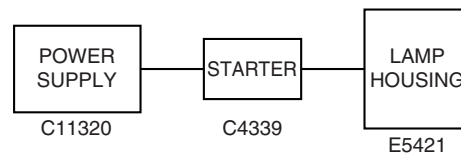
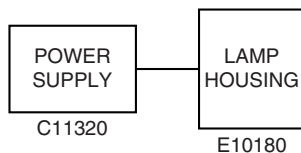
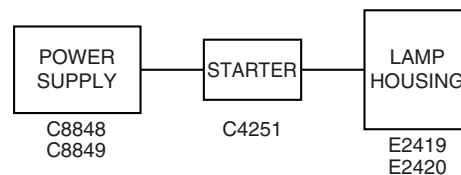
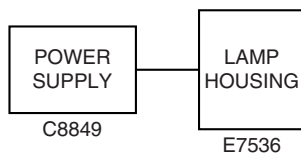

LAMP HOUSING

Hamamatsu provides various lamp housings to make our lamps easier to use. Besides using a stable power supply, it is also essential to use a proper lamp housing to extract full performance from the lamps and obtain stable light output.

Four models of lamp housings are currently available. Among these, the E7536 and E10180 are designed for high accuracy yet easier handling, while the E2419, E2420 and E5421 feature simplified designs.

The E7536 and E10180 have an internal reflecting mirror and light output lens to provide a collimated light beam with high intensity. The built-in interlock function, starter and cooling fan enhance safety, for example, the surface temperature on the housing is kept below +40 °C during operation. The optical axis can be easily aligned with the adjuster screws from the outside of the housing.



E7536

TLSXF0129

● DIMENSIONAL OUTLINES (Unit: mm)

E2419/-01 (For 35 W, 50 W, 75 W and 100 W Lamps) E2420 (For 150 W and 200 W Lamps)

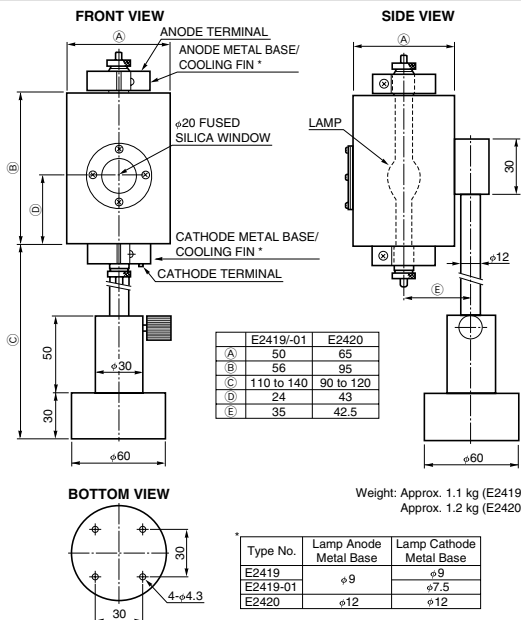

E7536/-01 (For 150 W and 200 W Lamps)

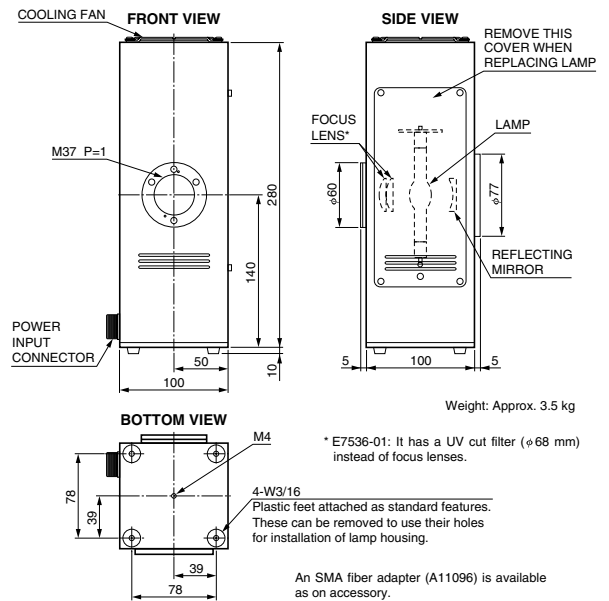

E5421 (For 300 W, 350 W and 500 W Lamps)

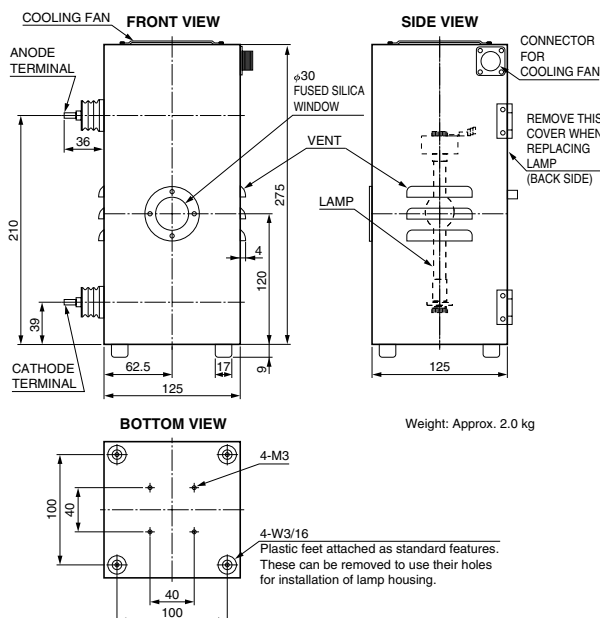

E10180/-01 (For 300 W, 350 W and 500 W Lamps)

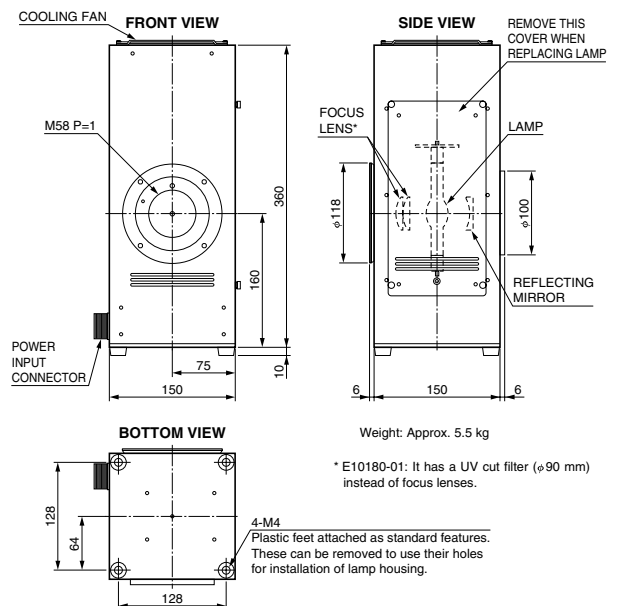

HANDLING PRECAUTION (Be sure to read before using lamp)

●Installation Precautions

1. Always handle the lamp very carefully.

The lamp is filled with high pressure gas (approx. 1 MPa at room temperature and approx. 4 MPa during operation). Subjecting the lamp to strong shocks or scratching the surface of the glass bulb might rupture the bulb, causing hazards from flying glass fragments.

When handling the lamp, always wear a protective mask, long-sleeved shirt and gloves for safety.

Keep the specified package that came supplied with the lamp, because it will be used for lamp replacement.

2. Never touch the silica glass bulb of the lamp with bare hands.

Operating the lamp with dust or grime still on the glass bulb causes it to thermally stick on the bulb and cuts the light transmittance. This results in low light output intensity and also lowers the mechanical strength of the glass bulb. If dust or grime adheres to the bulb, gently wipe it off the bulb using absorbent cotton or gauze moistened with high-quality alcohol and thoroughly wrung out. In such cases, use a proper protective mask, shirt and gloves mentioned above and take care not to apply any strong shocks to the lamp.

3. Install the lamp in a correct direction and polarity. (See Figure 15.)

Operating the lamp while installed in the wrong direction or polarity will damage the cathode, leading to permanent lamp defects.

[Vertical lighting]

To install the lamp in an upright position, make sure that the "UP" or "+" mark (anode mark) scribed on the metal base is positioned facing upwards.

[Horizontal lighting]

To install the lamp in a horizontal position, make sure that the sealed-off tip is positioned parallel to ground (horizontal plane). Use a magnet to adjust the position of the arc point so that the discharge stays along the center line of both electrodes. To obtain adequate performance from the lamp, it is essential to set the arc point at the correct position by using a proper magnet. (See Figure 16.)

Figure 15: Lamp Installation Direction and Polarity

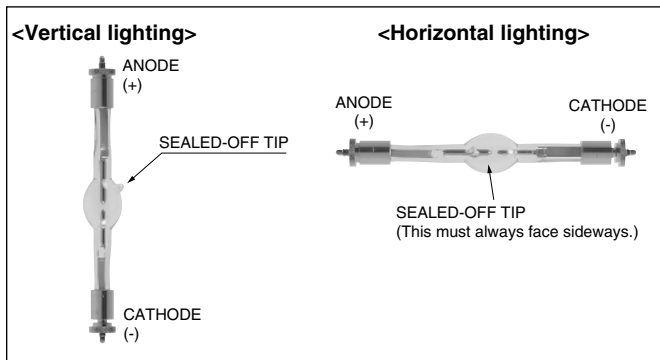

Figure 16-1

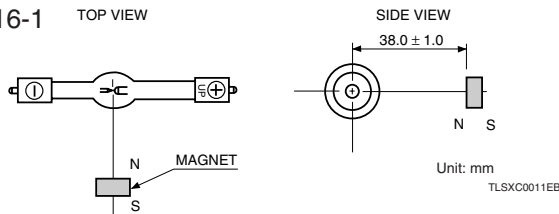
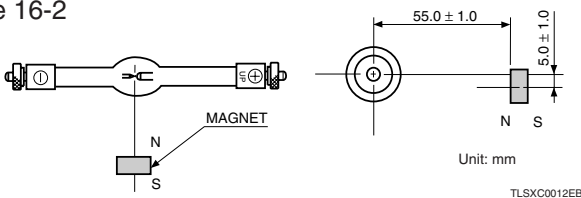

Figure 16-2



Power Consumption	Surface Magnetic Flux Density (mT)	Distance* (mm)	Magnet Example	Position (Direction)
35 W to 100 W	9.5 to 10.5	38.0±1.0	TDK FB3G D10 × 5S (10 mm dia., 5 mm thickness)	See Figure 16-1
150 W to 300 W	12.0 to 12.5	55.0±1.0	TDK FB3G D15 × 7S (15 mm dia., 7 mm thickness)	See Figure 16-2

* Distance from the center of arc to the surface of magnet.

●Operating Precautions

4. Observe high voltage and high temperature precautions.

Lamps discharge starts by application of a high trigger voltage of 20 kV to 30 kV. Sufficient insulation must be installed to prevent electrical shocks. When the lamp is used near equipment such as a PC (personal computer) which is vulnerable to noise, start the computer operation after the lamp has already been turned on.

The lamp is extremely hot during operation and also immediately afterwards, so do not touch the lamp with bare hands and do not let the lamp get close to flammable materials.

Never open the cover of the lamp housing during operation since the lamp is at an extremely high temperature.

If you have to open the cover, always use protective gear. (Refer to item 1.)

5. Observe ultraviolet radiation precautions

These lamps emit ultraviolet radiation which is harmful to the eyes and skin. Avoid looking directly at an operating lamp or exposing the skin directly to it since there is danger of burns to the skin or eyes.

Always wear a light-shielding protector (ISO 4849 or equivalent standard) during lamp operation.

6. Always observe the rated values (specifications).

The rated operating current is specified for each lamp type. (See the specifications on pages 8 and 9.)

If used outside the specified rated range, operation will become unstable and the service life will be shortened drastically. Lamps of 250 W or more require a fan for forced air cooling.

7. We recommend replacing the lamp by the guaranteed operation life. If using the lamp for longer than this period, replace it when the total operating time exceeds the average life plus 500 hours (plus 300 hours for 500 W mercury-xenon lamps), or when the inner wall of the bulb becomes extremely dark.

When the total operating time exceeds the average life plus 500 hours (plus 300 hours for 500 W mercury-xenon lamps), vaporization and spattering from the electrodes will adhere to the inner wall of the bulb, and speed up blackening of the bulb as well as disturbing heat dissipation. If this lamp is used continuously, the temperature (pressure) inside the lamp bulb increases abnormally, possibly causing the lamp to rupture or break.

●Precautions When Removing

8. Place the used lamp in the specified package that came supplied with the lamp.

When removing a used lamp from the lamp housing, be sure to wait until the lamp cools to room temperature and wear a protective mask, long-sleeved shirt and gloves for safety.

High pressure gas still remains even inside a used lamp. Rough handling may cause the lamp to rupture, so handle the used lamp as carefully as you would a new lamp.

9. Disposal of lamps

Lamps are filled with high pressure (approx. 1 MPa at room temperature) xenon gas (xenon gas and mercury in mercury-xenon lamps).

When disposing of the used lamp, take appropriate measures in compliance with applicable regulations regarding waste disposal and correctly dispose of it yourself, or entrust disposal to a licensed industrial waste disposal company.

In any case, be sure to comply with the regulations in your country, state, region or province to ensure the used lamp is disposed of legally and correctly.

●Caution Items When Designing Lamp Housings

A. The lamp housing must have a sturdy cover.

The lamp is filled with high pressure gas (approx. 1 MPa at room temperature and approx. 4 MPa during operation). Lamp housings must have a sturdy cover (enclosure) to avoid possible breakage.

B. Clamp the lamp only at one end of the lamp. Leave the other end unclamped.

(See Figure 17.)

The glass bulb expands from heat during operation. So if both metal base electrodes of the lamp are clamped by holders made of a hard material or having a rigid, inflexible frame, the glass bulb may eventually rupture. Always clamp the lamp at one end to permit the lamp to absorb thermal expansion. Leave the other end of the lamp unclamped. When designing the lamp housing, also be sure to note the operating temperature at the metal bases of the lamp. (Refer to item D.)

C. Use caution when focusing the light, so that the lamp operating temperature will not rise abnormally.

When focusing the light from the lamp with a mirror or other means, be sure not to focus it onto the bulb wall or electrodes. Doing so increases the lamp operating temperature excessively.

Always be careful with the lamp operating temperature when using a condenser mirror. (See Item D.)

D. Use caution to avoid excessive temperature rise during operation. (See Figure 17.)

The lamp should be operated at less than 750 °C on the bulb surface and at less than 200 °C on the metal base surface. If the lamp operating temperature exceeds these upper limits, "oxidation of electrode leads" and "excessive wear on electrodes or consumption of enclosed gas" may occur, leading to a significant reduction in lamp life. In addition, the pressure inside the lamp may rise abnormally, possibly causing cracks or breakage in the glass portion around the leads. Allow for a safety margin for thermal heat emitted from the lamp housing and provide a structure or use materials that efficiently dissipate or conduct away heat. Do this, for example, by attaching a heatsink to the anode metal base.

If the lamp holder makes poor contact with the metal base or contact resistance increases due to an oxidized contact piece, the lamp operating temperature will rise abnormally. Take sufficient precautions to avoid this.

Forced air cooling by fan is necessary for lamps of 250 W or more. The cooling fan must be designed to continue operation for 3 minutes to 5 minutes even after the lamp is turned off so that the fan will not stop during lamp operation.

E. Maintain adequate insulation to avoid trigger voltage leakage.





Use high quality insulation materials and maintain sufficient insulation gaps since an extremely high trigger voltage of 20 kV to 30 kV is applied to the lamp for start-up. (An insulation gap of 1 cm will withstand only about 10 kV, though this also depends on relative humidity. We recommend an insulation gap of at least 3 cm.)

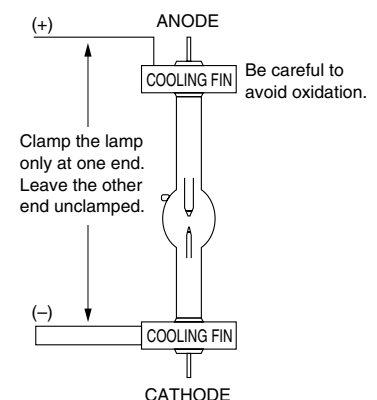



Use a power supply cable capable of withstanding high voltages more than 30 kV. To avoid electrical leakage from the cable surface, do not bundle it up during wiring. The power cable layout should be as short as possible, and should not be passed through a metal opening (or should not be in contact with a metal surface) of the chassis or enclosure. If such a cable layout is not practical, use high-quality silicon insulating tube to cover the power cable, or install insulating material around the metal opening (or metal surface).

Figure 17



TL5XC0049EB

 WARNING		<ul style="list-style-type: none"> ●Lamps emit ultraviolet radiation. Never stare directly into the operating lamp. <ul style="list-style-type: none"> • Ultraviolet radiation will irritate the eyes and might impair eyesight. ●Do not allow skin to be exposed to ultraviolet radiation. <ul style="list-style-type: none"> • Ultraviolet radiation may cause skin inflammation. ●Do not bring the lamp close to any flammable materials such as cloth or paper. <ul style="list-style-type: none"> • Doing so might cause fires.
		<ul style="list-style-type: none"> ●The lamp remains at high temperatures during and shortly after operation. Never let any part of the heated lamp come in contact with your hands or skin. <ul style="list-style-type: none"> • The heated lamp will cause burns.
		<ul style="list-style-type: none"> ●Be careful not to drop the lamp, subject it to impacts, apply excessive force or scratch it, because the pressure inside the glass bulb is very high and might cause it to rupture. <ul style="list-style-type: none"> • Injury may result if the lamp is broken.
		<ul style="list-style-type: none"> ●Always operate the lamp after installing it in the lamp housing. <ul style="list-style-type: none"> • Injury may result if the lamp is broken. ●Always turn off the power supply when installing or removing the lamp, or when cleaning the lamp or housing. <ul style="list-style-type: none"> • Failure to do this may result in electrical shocks, pain in the eyes, damage to eyesight or skin burns.

 CAUTION		<ul style="list-style-type: none"> ●Install the lamp in the correct direction and polarity. <ul style="list-style-type: none"> • Incorrect installation might damage the lamp.
		<ul style="list-style-type: none"> ●Be sure to use a power supply that provides an optimal current value for the lamp. <ul style="list-style-type: none"> • Using the wrong power supply might cause overheating and damage the lamp.
		<ul style="list-style-type: none"> ●Do not use the lamp in damp locations subject to raindrops or water droplets, high humidity, etc. <ul style="list-style-type: none"> • Operating the lamp in high humidity may result in electrical shocks or damage the lamp.
		<ul style="list-style-type: none"> ●Always wear a protective mask and garment when installing or removing the lamp. <ul style="list-style-type: none"> • If broken, exploding glass fragments may cause injury.

WARRANTY Lamps are warranted for a period of one year from the date of shipment. If a lamp is found to be defective within this warranty period, Hamamatsu will replace the defective lamp without charge. (This warranty is limited to replacement of the defective lamp.) Even if within the warranty period (one year), the warranty shall not apply to cases where the lamp operation time has exceeded the guaranteed life, or the trouble was caused by incorrect operation or natural or man-made disasters.

RELATED PRODUCTS

Super-Quiet Xenon Flash Lamp

Xenon flash lamps feature a compact construction, lower heat generation, and stable light output with instantaneously higher peaks compared to xenon lamps.

Hamamatsu provides various types of xenon flash lamps such as the SQ type with high stability and long service life, the HQ type for general use, a high power type with a built-in reflector, and 60 W type sealed in a metal can. Select the lamp that best matches your application.

These lamps are widely used for various kinds of tasks including flash lamps and stroboscopes for high-speed cameras, factory automation, chemical analysis and biological studies.



Long Life 100 W Xenon Short Arc Reflector Lamp L10878

The L10878 consists of a long-life 100 W xenon lamp precisely assembled with a condenser reflector.

The L10878 does not require optical systems and optical axis adjustment mechanisms that are necessary for ordinary xenon lamps. This simplifies equipment design and makes lamp replacement easy since no optical axis adjustment is required.



Calibrated Xenon Lamp Light Source L7810, L7810-02 (Manufactured upon receiving your order)

These light sources deliver the extremely high levels of "stability" and "repeatability" essential to a calibrated light source. These are available as an optimal set including a lamp, lamp housing and power supply, so that anyone can easily reproduce a highly stable light output.

Since we are certified as an ASNITE-Calibration laboratory, we are capable of calibrating spectral irradiance over a wide range from 200 nm to 800 nm (L7810-02).

The spectral range at wavelengths shorter than 250 nm is calibrated based on the ASNITE calibration system (Accreditation System of National Institute of Technology and Evaluation), while the spectral range at wavelengths longer than 250 nm is calibrated based on the JCSS (Japan Calibration Service System).



Left: Lamp housing, Right: Power supply

Subject to local technical requirements and regulations, availability of products included in this promotional material may vary. Please consult with our sales office. Information furnished by HAMAMATSU is believed to be reliable. However, no responsibility is assumed for possible inaccuracies or omissions. Specifications are subject to change without notice. No patent rights are granted to any of the circuits described herein. ©2012 Hamamatsu Photonics K.K.

HAMAMATSU PHOTONICS K.K. www.hamamatsu.com

HAMAMATSU PHOTONICS K.K., Electron Tube Division

314-5, Shimokanzo, Iwata City, Shizuoka Pref., 438-0193, Japan, Telephone: (81)539/62-5248, Fax: (81)539/62-2205

U.S.A.: Hamamatsu Corporation, 360 Foothill Road, P. O. Box 6910, Bridgewater, N.J. 08807-0910, U.S.A., Telephone: (1)908-231-0960, Fax: (1)908-231-1218 E-mail: usa@hamamatsu.com

Germany: Hamamatsu Photonics Deutschland GmbH, Arzbergerstr. 10, D-82211 Herrsching am Ammersee, Germany, Telephone: (49)8152-375-0, Fax: (49)8152-2658 E-mail: info@hamamatsu.de

France: Hamamatsu Photonics France S.A.R.L.: 19, Rue du Saule Trappu, Parc du Moulin de Massy, 91882 Massy Cedex, France, Telephone: (33)1 69 53 71 00, Fax: (33)1 69 53 71 10 E-mail: infos@hamamatsu.fr

United Kingdom: Hamamatsu Photonics UK Limited: 2 Howard Court, 10 Tewin Road Welwyn Garden City Hertfordshire AL7 1BW, United Kingdom, Telephone: 44-(0)1707-294888, Fax: 44(0)1707-325777 E-mail: info@hamamatsu.co.uk

North Europe: Hamamatsu Photonics Norden AB: Smidesvägen 12, SE-171-41 SOLNA, Sweden, Telephone: (46)8-509-031-00, Fax: (46)8-509-031-01 E-mail: info@hamamatsu.se

Italy: Hamamatsu Photonics Italia: S.R.L.: Strada della Moia, 1/E, 20020 Arese, (Milano), Italy, Telephone: (39)02-935 81 733, Fax: (39)02-935 81 741 E-mail: info@hamamatsu.it

China: Hamamatsu Photonics (China) Co., Ltd.: 1201 Tower B, Jiaming Center, 27 Dongsanhuan Road North, Chaoyang District, Beijing 100020, China, Telephone: (86)10-6586-6006, Fax: (86)10-6586-2866 E-mail: hpc@hamamatsu.com.cn

TLSX1044E05
SEPT. 2012 IP